

ISO

1)TOP.
2)BOTTOM.

Dept. MECH	Technical reference	Created by HEMANTH C	9/9/2020	Approved by PRATHEEK	9/9/2020
		Document type PDF	Document status		
		Title PES02(SMALL) PROBOTS	DWG No. 1		
		Rev.	Date of issue 9/9/2020	Sheet 1/2	

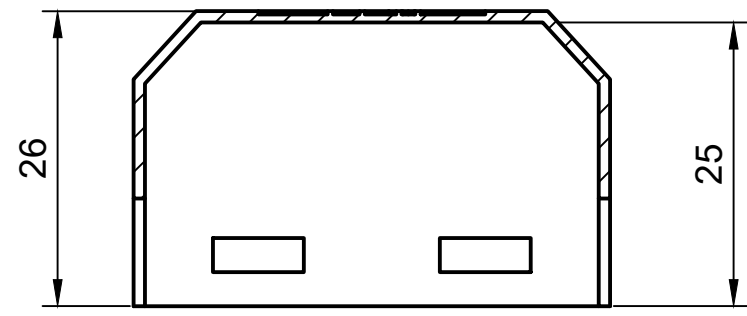

TOP(SECTION)



BOTTOM(SECTION)

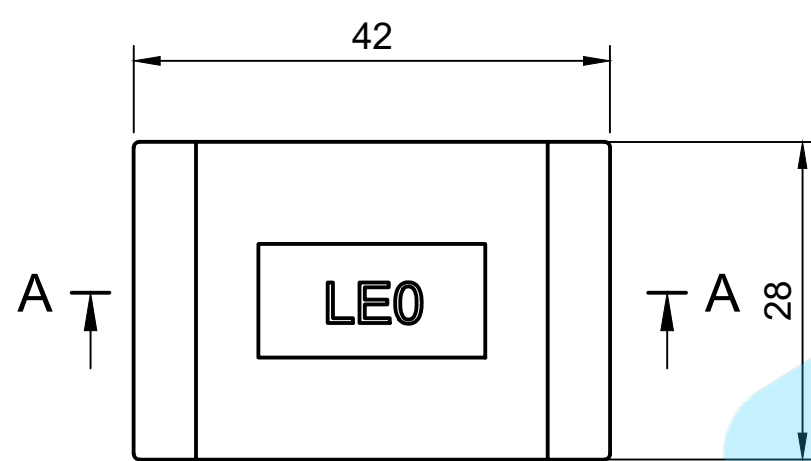

TOP(OD)

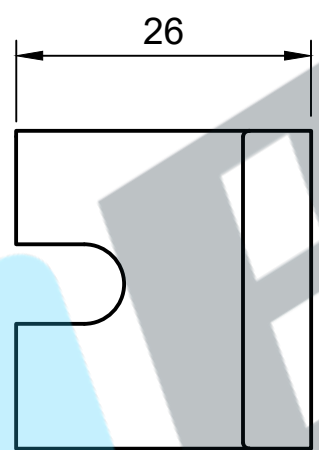

TOP(SIDE)

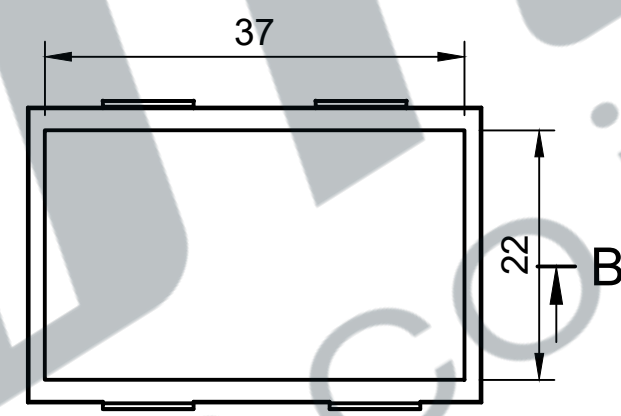

BOTTOM(ID)

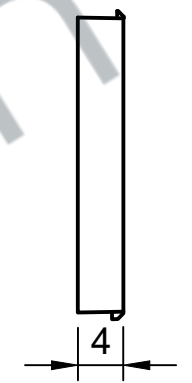

BOTTOM(SIDE)

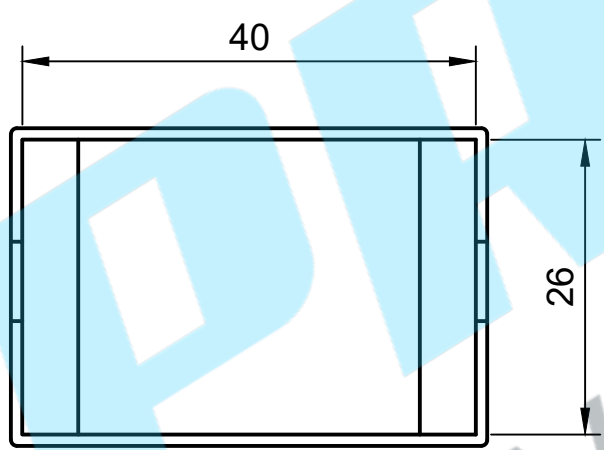

TOP(ID)

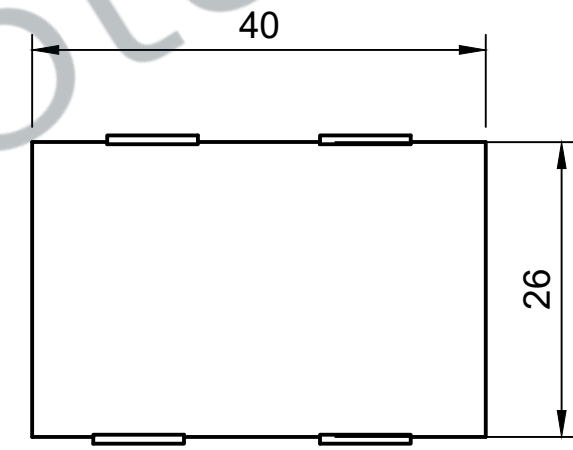

BOTTOM(OD)

NOTE:All dimenstions are in mm.
OD-Outer diameter;ID-Inner diameter.

Dept. MECH	Technical reference	Created by HEMANTH C	9/9/2020	Approved by PRATHEEK	9/9/2020
		Document type PDF	Document status		
		Title PES02(SMALL) PROBOTS	DWG No. 1		
		Rev.	Date of issue 9/9/2020	Sheet 2/2	